

LEGENDE

- EOLIENNE VESTAS V126
- EOLIENNE NORDEX N131
- ZONE DE GRUTAGE EN CAILLOUTIS
- CHEMIN D'ACCES A RENFORCER
- / HAIE A CONSERVER / A SUPPRIMER

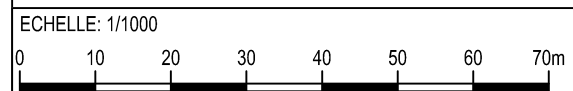

	INERSYS ZA des Métairies II - BP 48 - NIVILLAC 56130 LA ROCHE BERNARD Tél: 02 99 90 87 07 Fax: 02 99 90 73 08	Projet PARC EOLIEN BEAULIEU	Titre 17 - PLAN D'IMPLANTATION PROJETE EOLIENNE 3 + POSTE DE LIVRAISON	Date 27/06/2017	Chef de projet S. MAURER	
				Dessinateur L.PALVADEAU		
				VESTAS V126 / NORDEX N131		

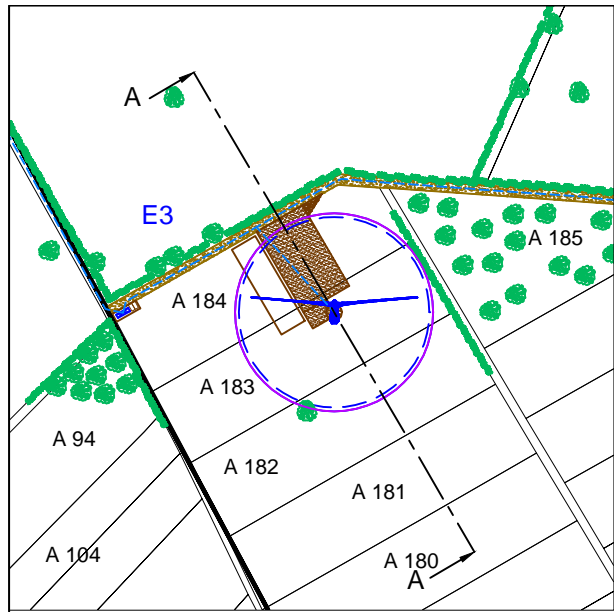

Ht sommet: 180.3m
NGF: 412.3m

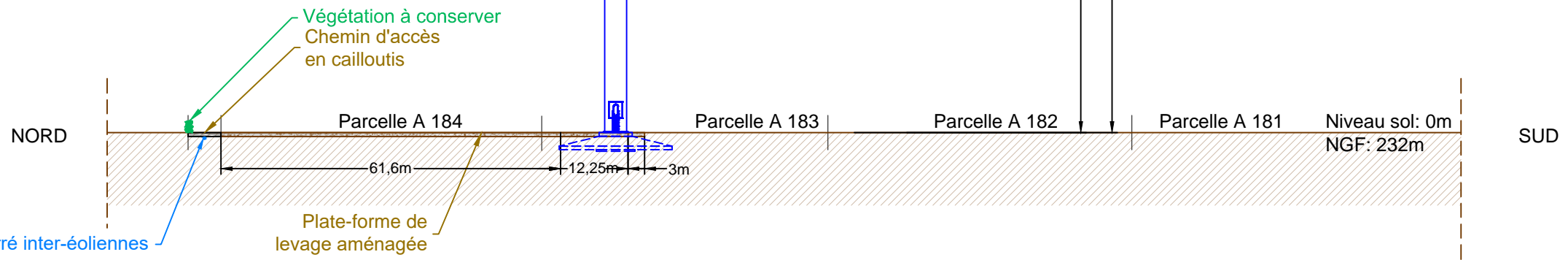
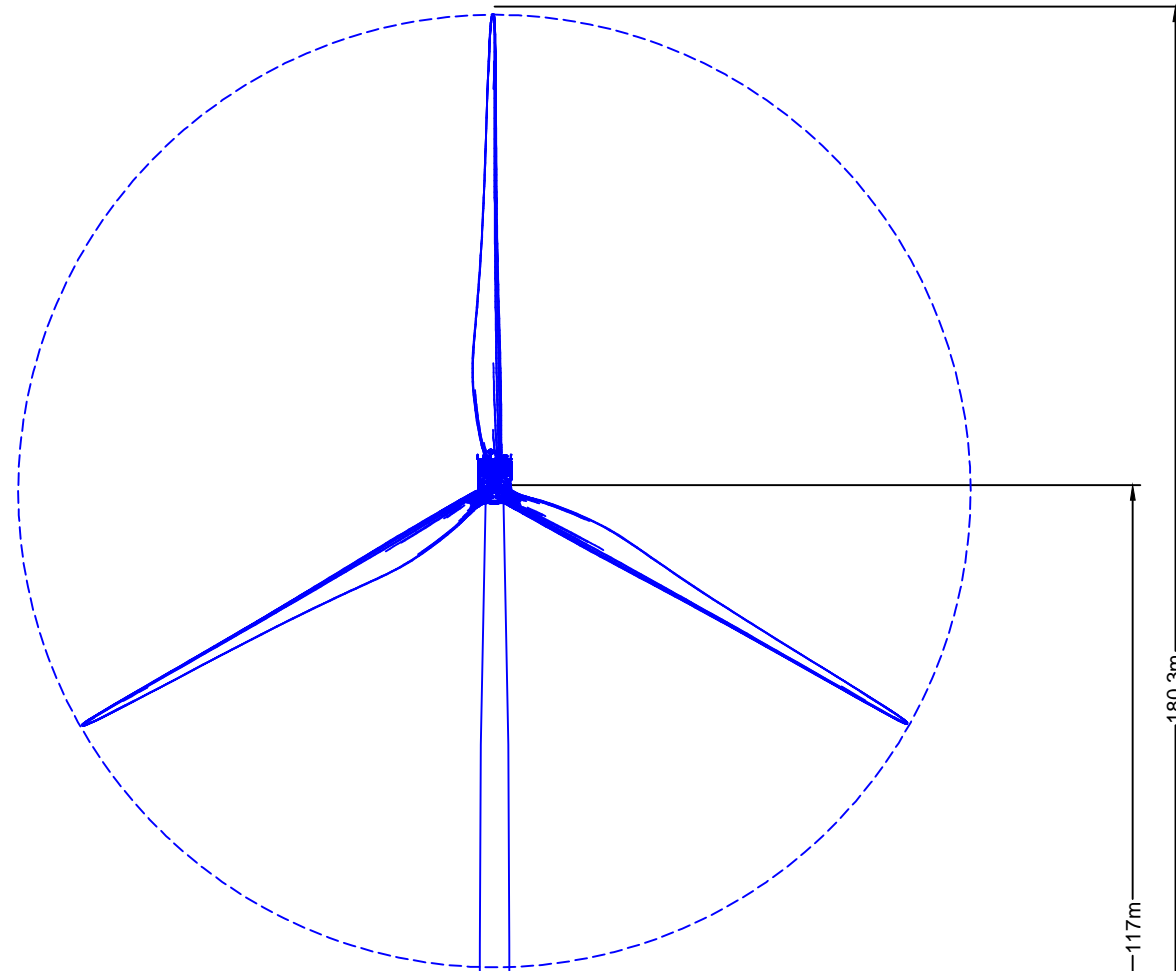

 <p>INERSYS ZA des Métairies II - BP 48 - NIVILLAC 56130 LA ROCHE BERNARD</p> <p>Tél: 02 99 90 87 07 Fax: 02 99 90 73 08</p>	<p>Projet</p> <p>PARC EOLIEN BEAULIEU</p>	<p>Titre</p> <p>18 - PLAN EN COUPE EOLIENNE 3 - V126</p>	Date	27/06/2017
			Chef de projet	S. MAURER
			Dessinateur	L.PALVADEAU
			<p>VESTAS V126 / NORDEX N131</p>	

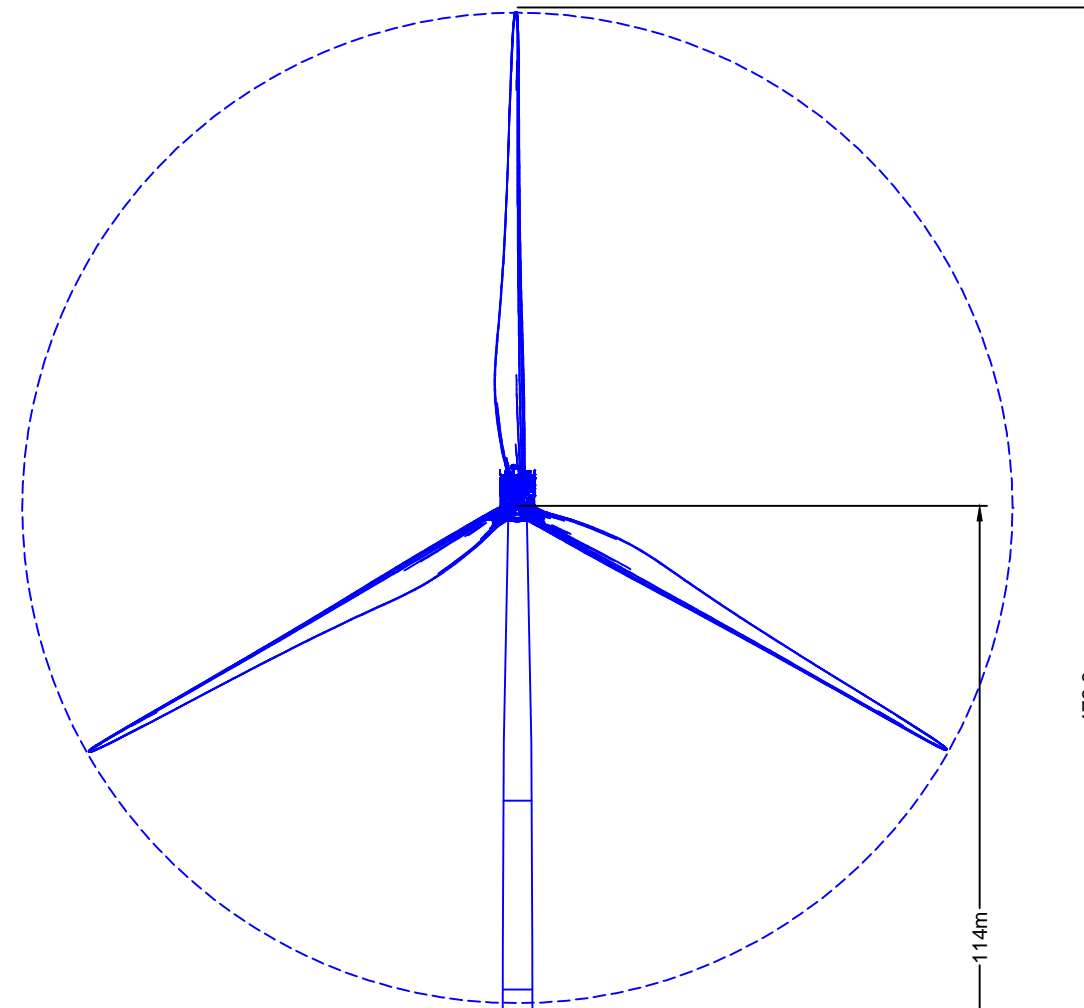
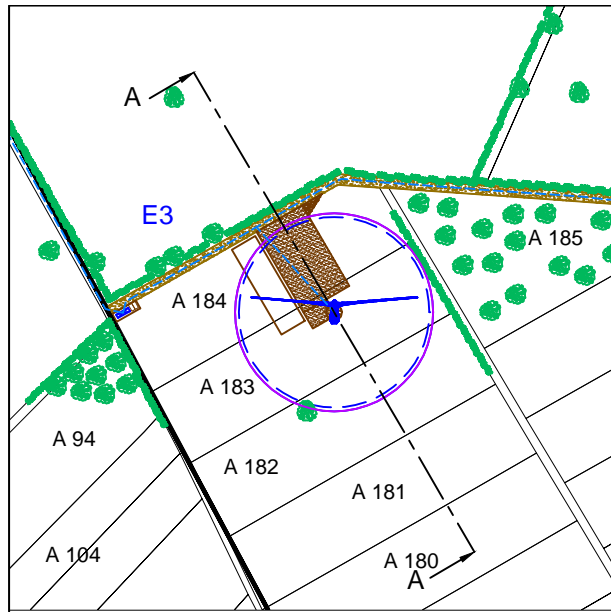

Ht sommet: 179.9m
NGF: 411.9m

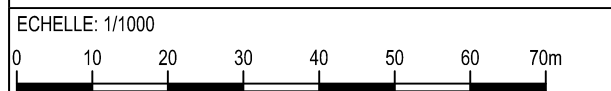
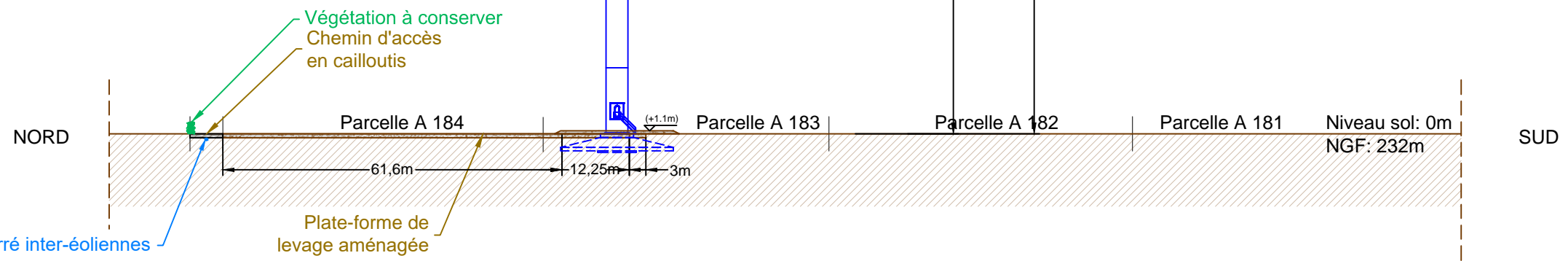

<p>INERSYS ZA des Métairies II - BP 48 - NIVILLAC 56130 LA ROCHE BERNARD</p> <p>Tél: 02 99 90 87 07 Fax: 02 99 90 73 08</p>	<p>Projet</p> <p>PARC EOLIEN BEAULIEU</p>	<p>Titre</p> <p>18' - PLAN EN COUPE EOLIENNE 3 - N131</p>	Date	27/06/2017
			Chef de projet	S. MAURER
			Dessinateur	L.PALVADEAU
			<p>VESTAS V126 / NORDEX N131</p>	

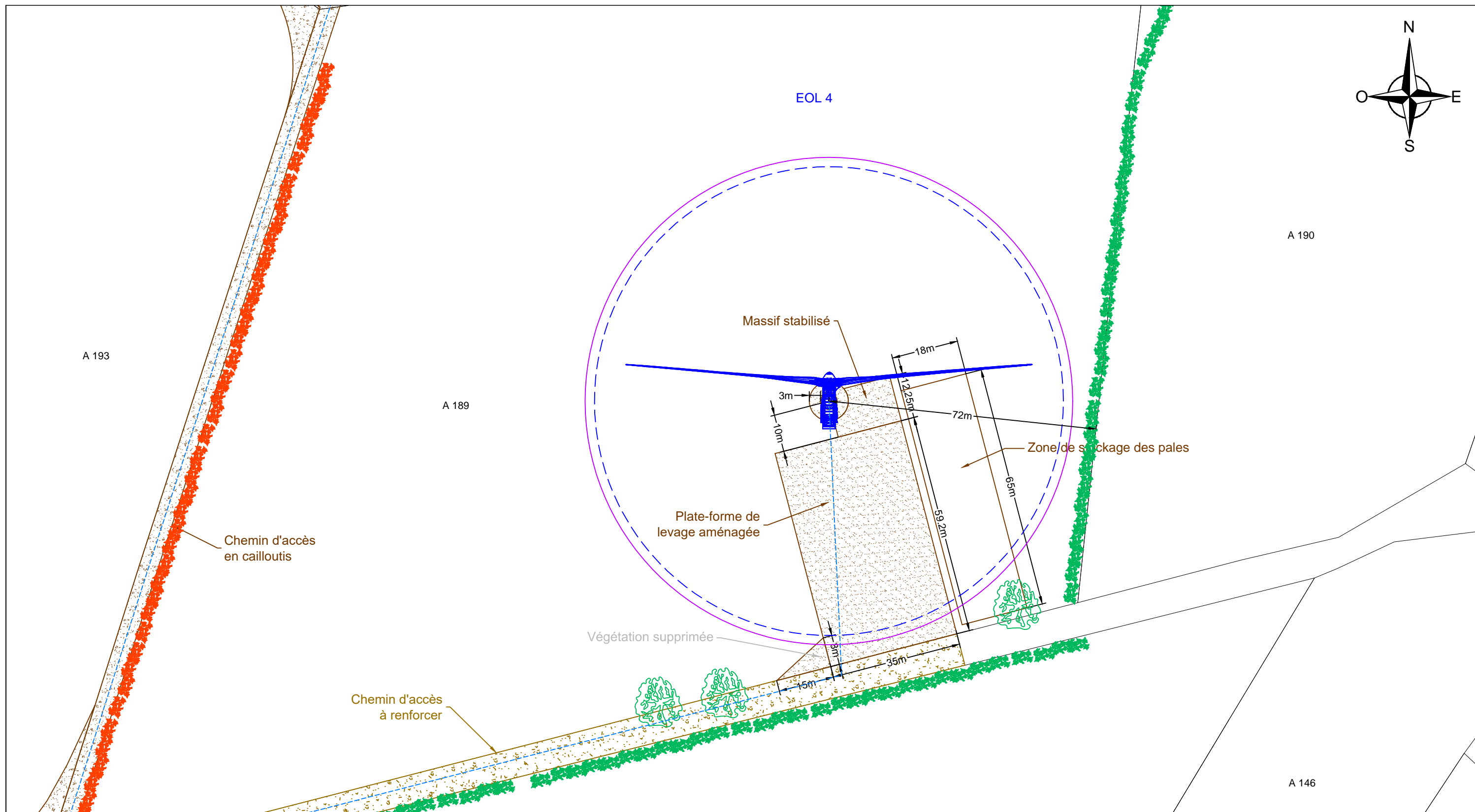

LEGENDE

- EOLIENNE VESTAS V126
- EOLIENNE NORDEX N131
- ZONE DE GRUTAGE EN CAILLOUTIS
- CHEMIN D'ACCES A CREER
- CHEMIN D'ACCES A RENFORCER
- HAIE A CONSERVER / A SUPPRIMER / A PLANTER

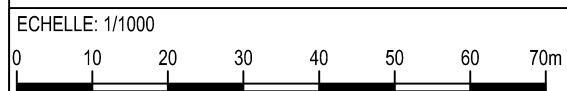

	INERSYS ZA des Métaïries II - BP 48 - NIVILLAC 56130 LA ROCHE BERNARD Tél: 02 99 90 87 07 Fax: 02 99 90 73 08	Projet PARC EOLIEN BEAULIEU	Titre 19 - PLAN D'IMPLANTATION PROJETE EOLIENNE 4	Date	27/06/2017
				Chef de projet	S. MAURER
				Dessinateur	L.PALVADEAU
				VESTAS V126 / NORDEX N131	

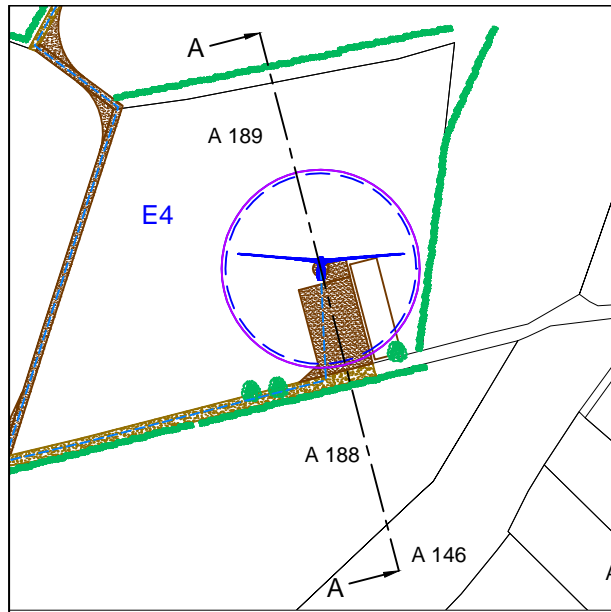

Ht sommet: 180.3m
NGF: 403.3m

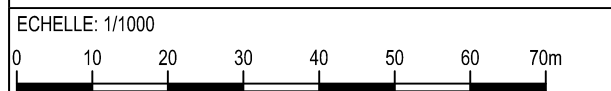
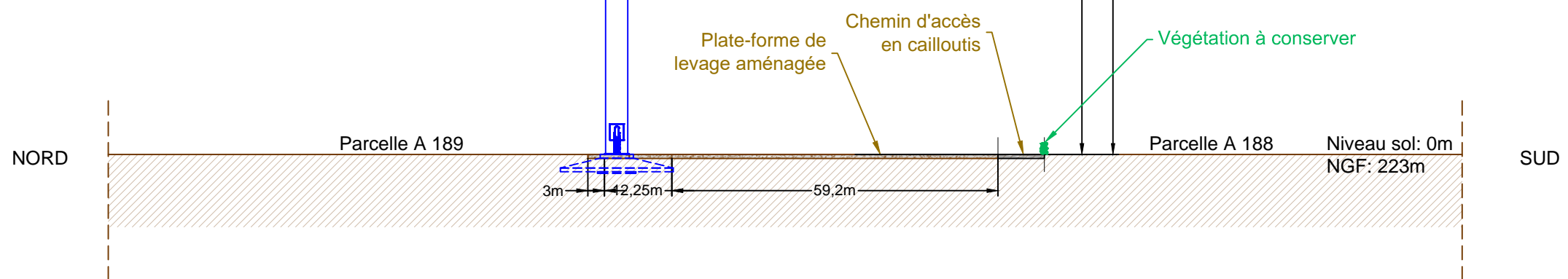
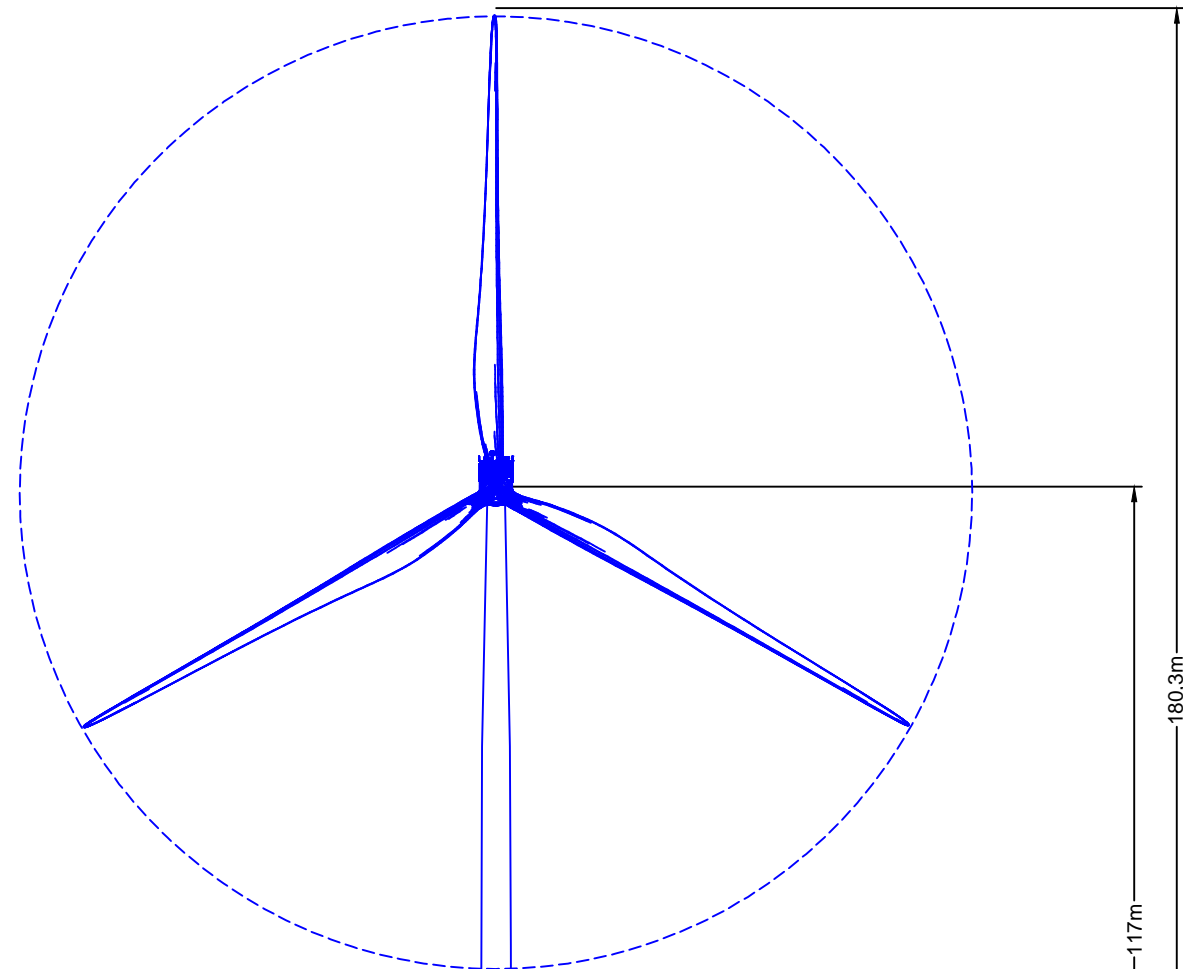

 <p>INERSYS ZA des Métairies II - BP 48 - NIVILLAC 56130 LA ROCHE BERNARD</p>	<p>Tél: 02 99 90 87 07 Fax: 02 99 90 73 08</p>	<p>Projet PARC EOLIEN BEAULIEU</p>	<p>Titre 20 - PLAN EN COUPE EOLIENNE 4 - V126</p>	Date	27/06/2017
				Chef de projet	S. MAURER
				Dessinateur	L.PALVADEAU
				VESTAS V126 / NORDEX N131	

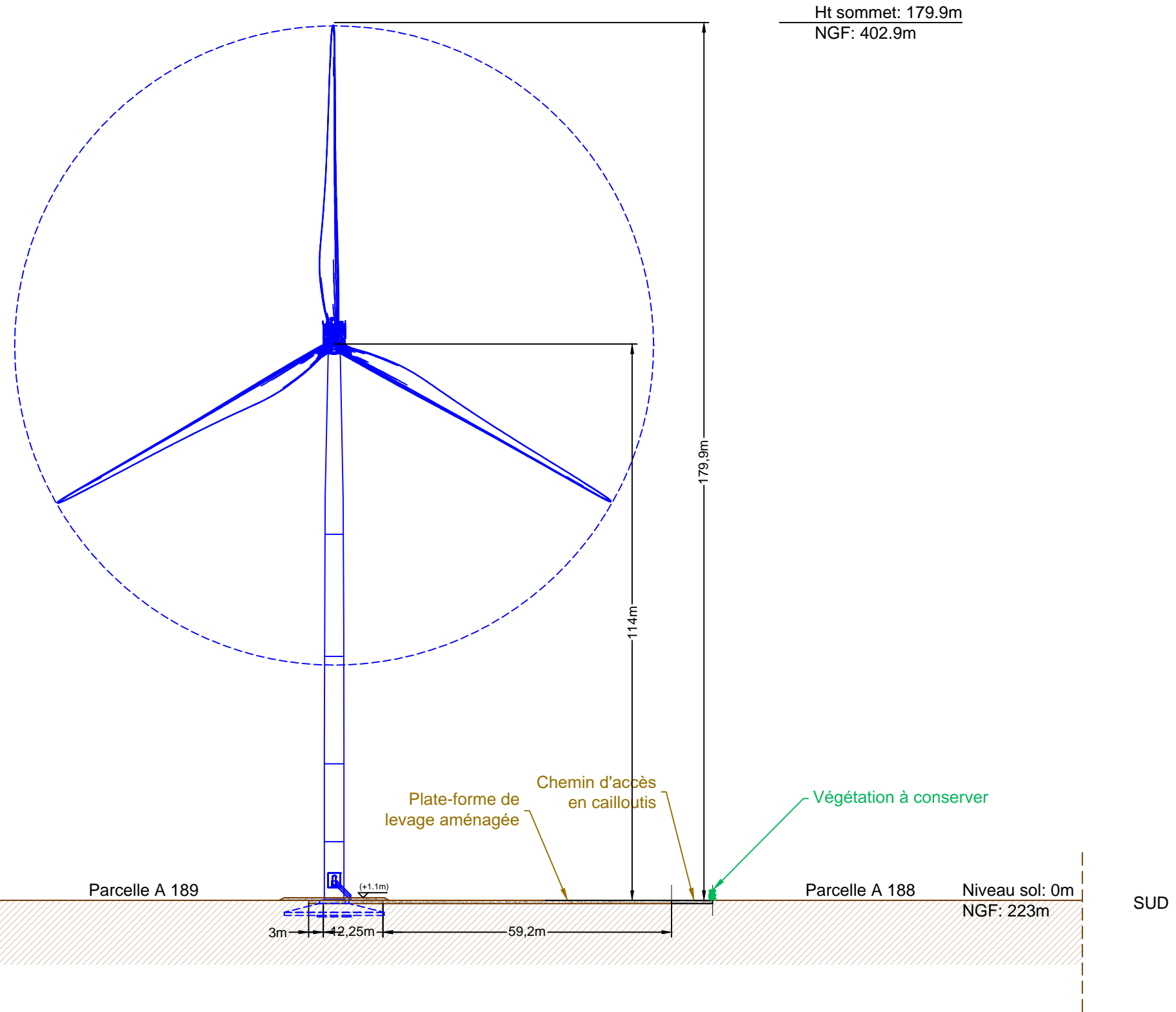
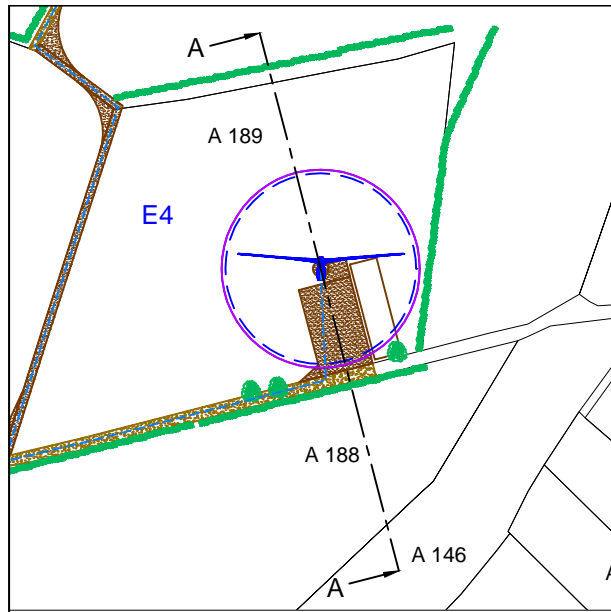

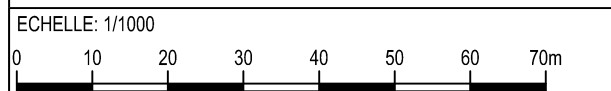

Ht sommet: 179.9m
NGF: 402.9m

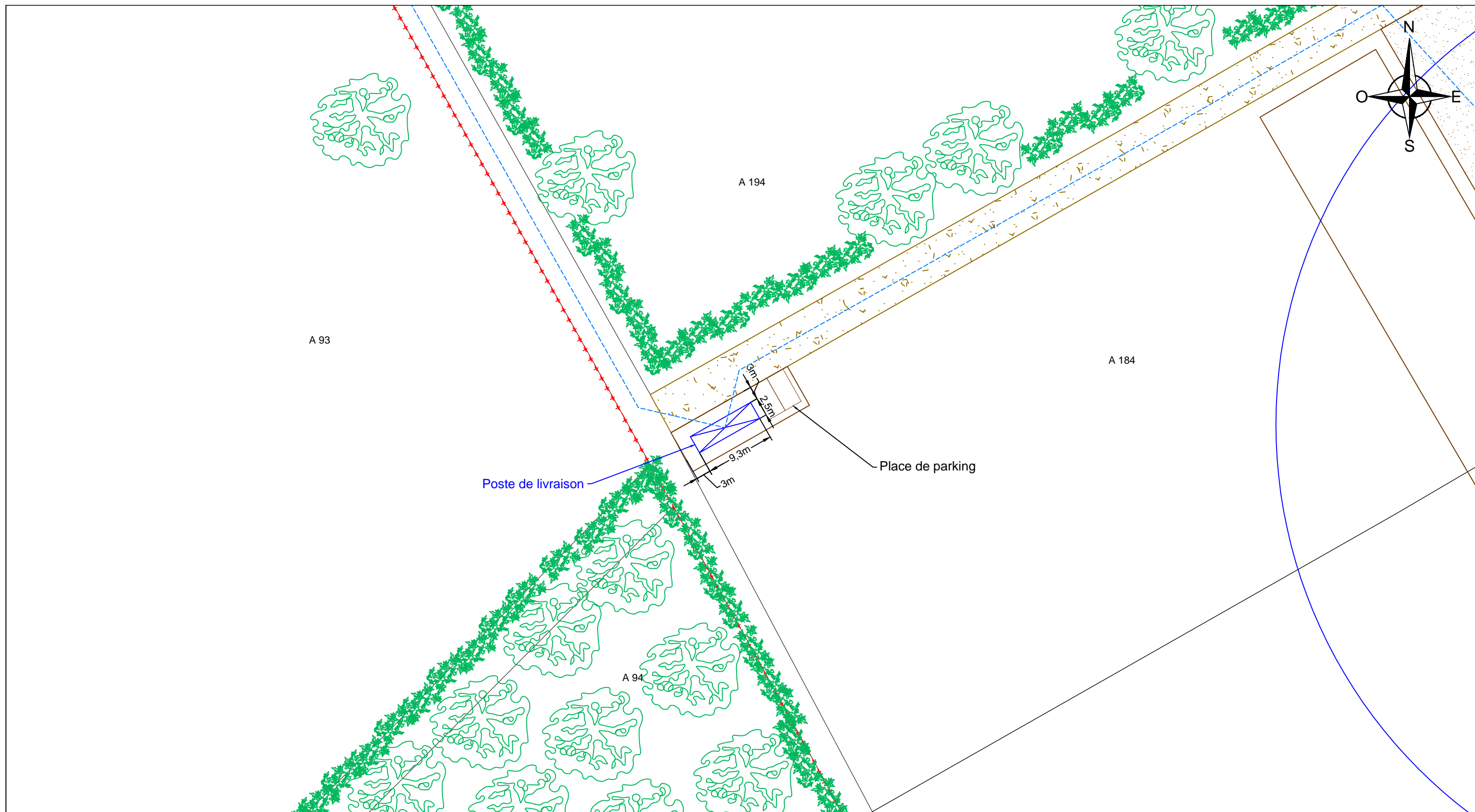

 <p>INERSYS ZA des Métairies II - BP 48 - NIVILLAC 56130 LA ROCHE BERNARD</p> <p>Tél: 02 99 90 87 07 Fax: 02 99 90 73 08</p>	<p>Projet</p> <p>PARC EOLIEN BEAULIEU</p>	<p>Titre</p> <p>20' - PLAN EN COUPE EOLIENNE 4 - N131</p>	Date	27/06/2017
			Chef de projet	S. MAURER
			Dessinateur	L.PALVADEAU
			<p>VESTAS V126 / NORDEX N131</p>	



LEGENDE

-  CHEMIN D'ACCES A RENFORCER
-  LIMITE DE COMMUNE

ECHELLE: 1/500

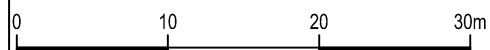

INERSYS

ZA des Métairies II - BP 48 - NIVILLAC
56130 LA ROCHE BERNARD

Tél: 02 99 90 87 07
Fax: 02 99 90 73 08

Projet

**PARC EOLIEN
BEAULIEU**

Titre

**21 - PLAN D'IMPLANTATION
POSTE DE LIVRAISON**

Date	27/06/2017
Chef de projet	S. MAURER
Dessinateur	L.PALVADEAU
VESTAS V126 / NORDEX N131	

COUPE AA

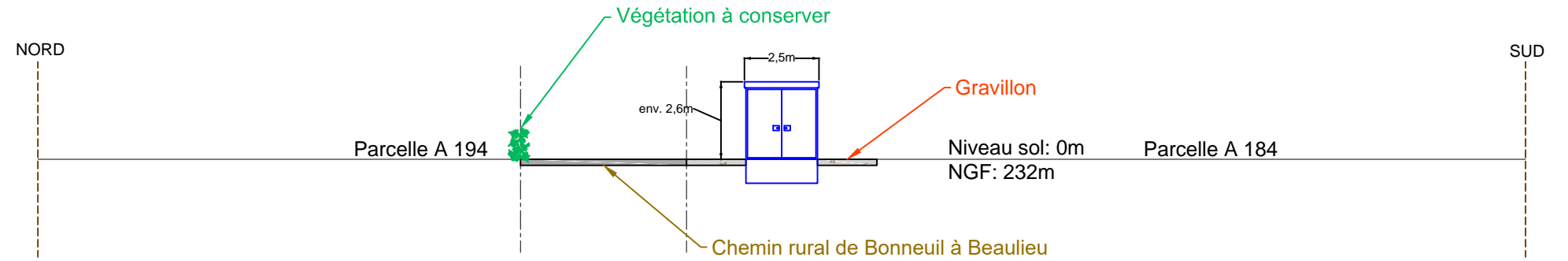
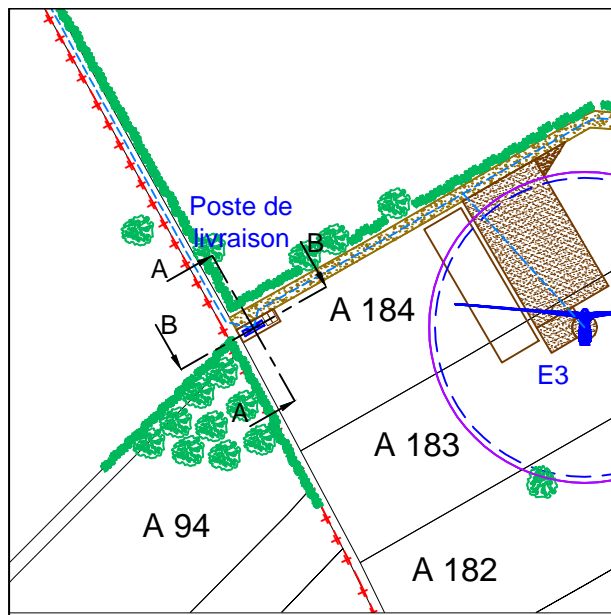

COUPE BB

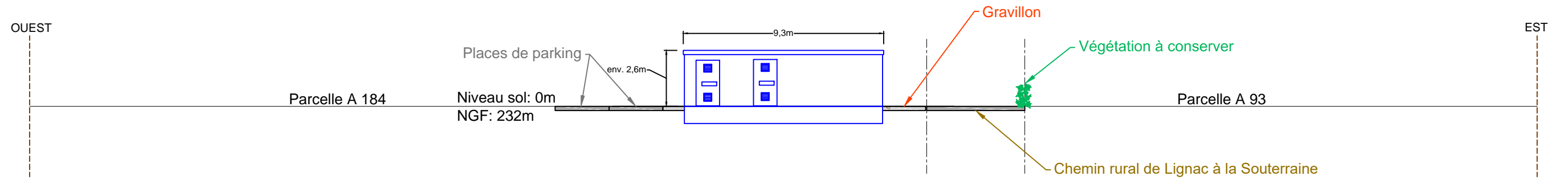

INERSYS

ZA des Métairies II - BP 48 - NIVILLAC
56130 LA ROCHE BERNARD

Tél: 02 99 90 87 07
Fax: 02 99 90 73 08

Projet

**PARC EOLIEN
BEAULIEU**

Titre

**22 - PLAN EN COUPE
POSTE DE LIVRAISON**

Date	27/06/2017
Chef de projet	S. MAURER
Dessinateur	L.PALVADEAU
VESTAS V126 / NORDEX N131	

COUPE C-C

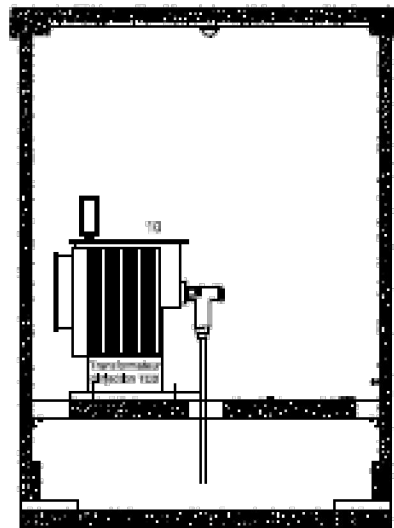

COUPE A-A

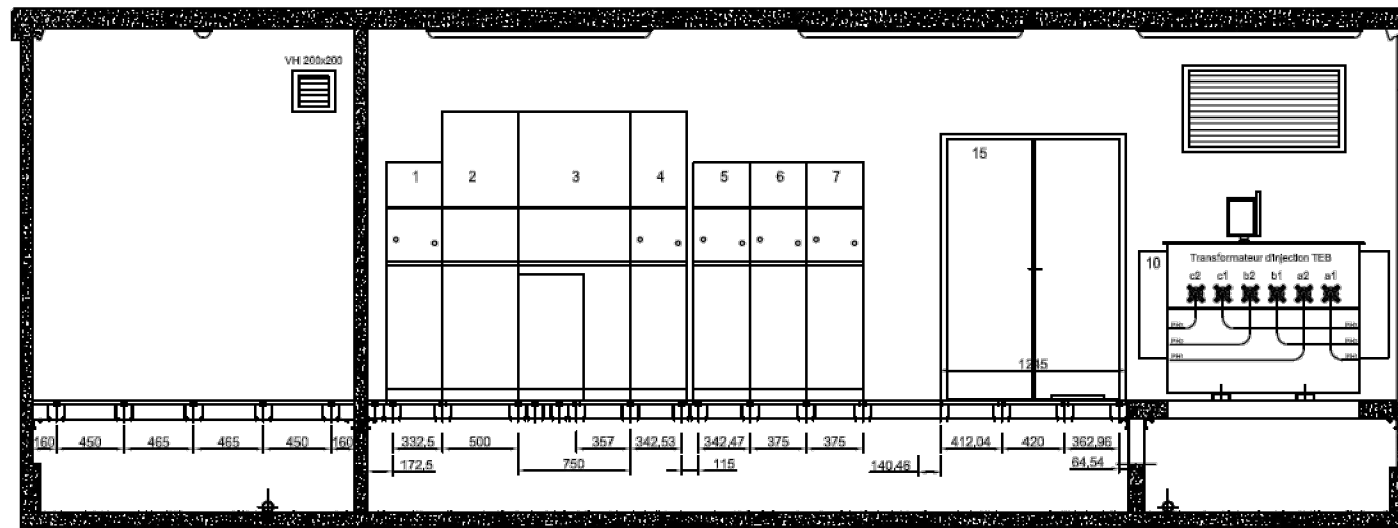

COUPE D-D

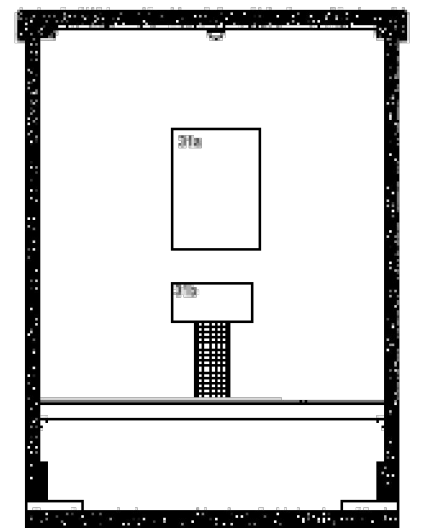

Local technique

VUE DE DESSUS

Local HTA

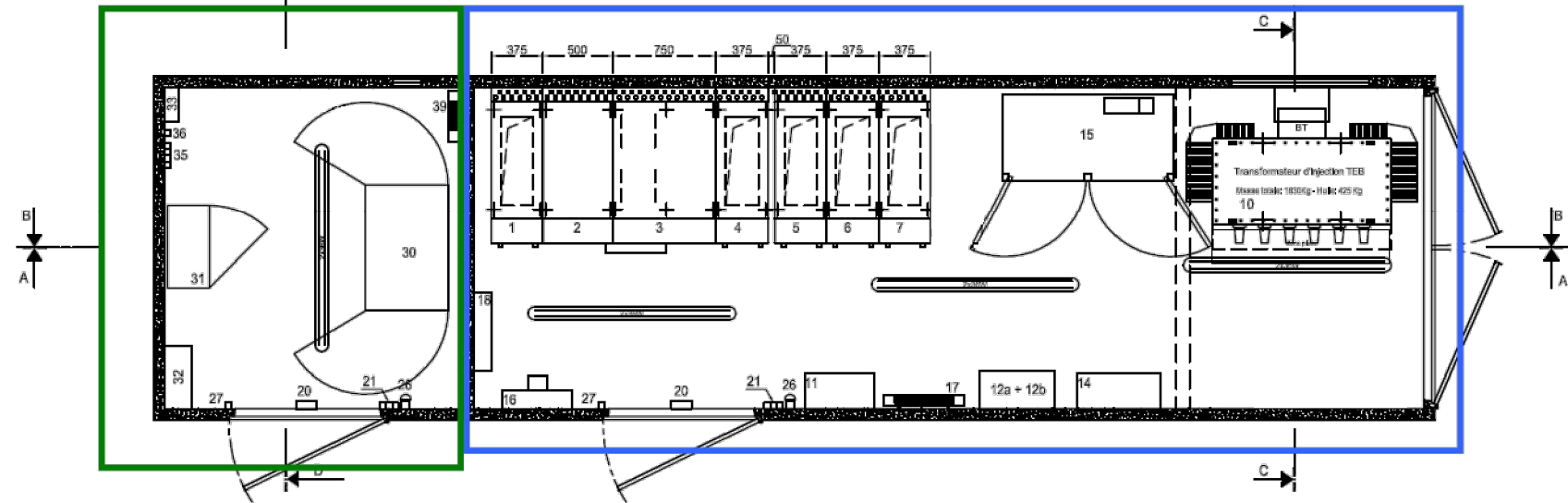

COUPE B-B

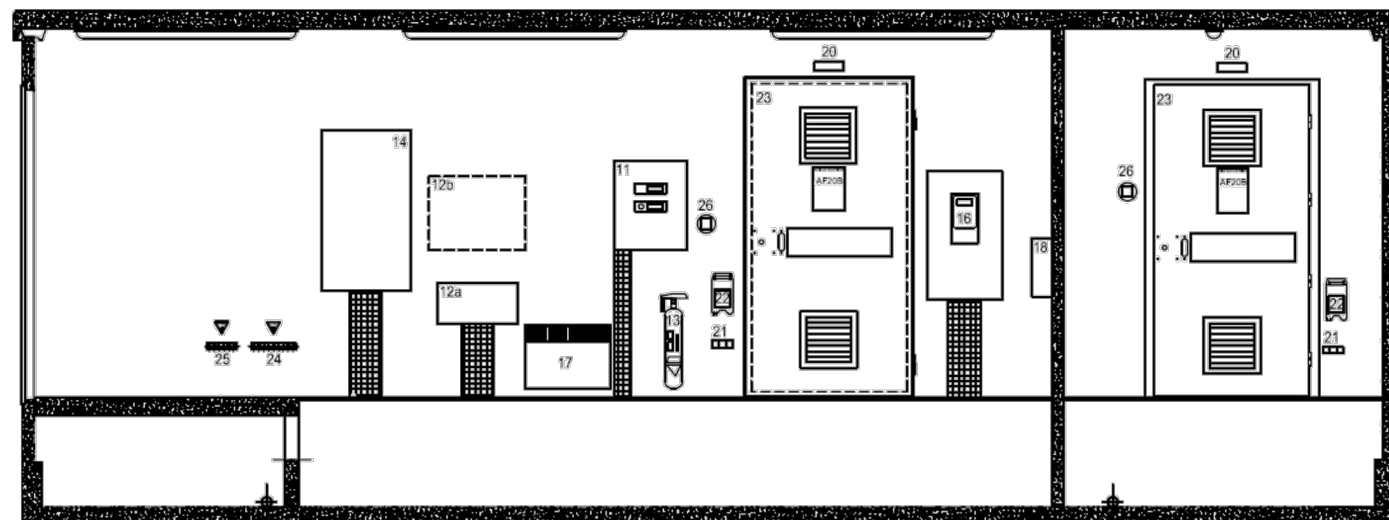

Repère	DESIGNATION
1	Cellule HTA " EDF"
2	Cellule HTA "Mesure Tension"
3	Cellule HTA "Disjoncteur général"
4	Cellule HTA "arrivée filtre"
5	Cellule HTA "Départ filtre"
6	Cellule HTA "arrivée parc"
7	Cellule HTA "arrivée parc"
8	
9	
10	Transformateur d'injection TEB
11	Chargeur 48 Vcc
12a	Coffret frontière D.E.I.E
12b	Coffret D.E.I.E (en attente)
13	Extincteur
14	Coffret de distribution BT
15	Armoire générateur FAS (P=450kg)
16	Comptage EDF
17	Convecteur 1000w
18	Accessoires de sécurité
19	
20	Bloc autonome d'éclairage de sécurité
21	3 prises de courant 2P+T
22	Bloc de secours portatif
23	Porte avec affichage réglementaire
24	Barrette de terre général poste
25	Barrette de terre (neutre)
26	Arrêt d'urgence
27	Interrupteur
30	Vestas Online Business (P=330kg) L910xP610xH1740
31a	Vestas Grid Panel (VGMS) 800x600x300
31b	Coffret frontière pour Vestas Grid Panel
32	Coffret de distribution BT
33	Coffret protection téléphonique
34	
35	Prise de courant (nb=4)
36	Prise téléphone (conjoncteur)
37	
38	
39	Convecteur 750w

**Plan d'implantation
d'un poste de
livraison standard
pour un parc éolien**

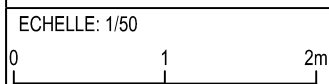

<p>INERSYS ZA des Métairies II - BP 48 - NIVILLAC 56130 LA ROCHE BERNARD</p> <p>Tél: 02 99 90 87 07 Fax: 02 99 90 73 08</p>	<p>Projet</p> <p>PARC EOLIEN BEAULIEU</p>	<p>Titre</p> <p>23 - PLAN EN COUPE POSTE DE LIVRAISON TYPE</p>	Date	27/06/2017
			Chef de projet	S. MAURER
			Dessinateur	L.PALVADEAU
			VESTAS V126 / NORDEX N131	

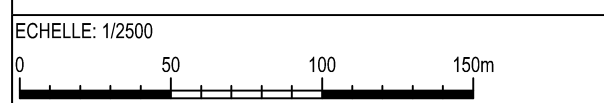
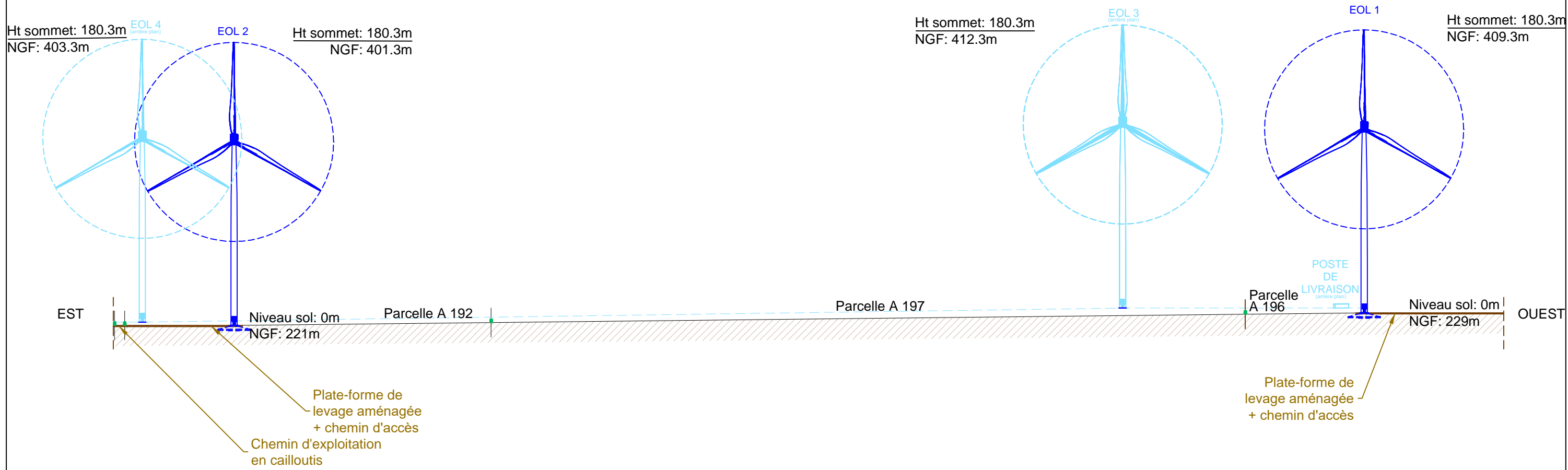
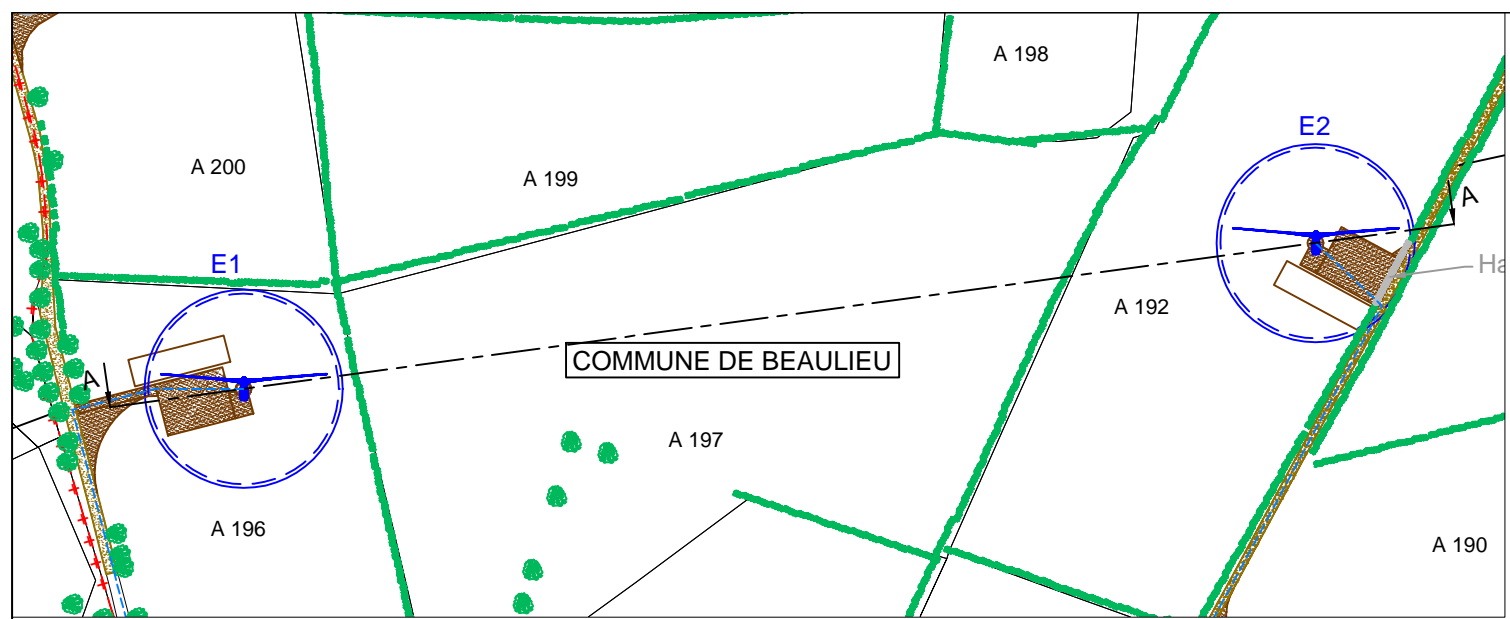

 <p>INERSYS ZA des Métairies II - BP 48 - NIVILLAC 56130 LA ROCHE BERNARD</p> <p>Tél: 02 99 90 87 07 Fax: 02 99 90 73 08</p>	<p>Projet</p> <p>PARC EOLIEN BEAULIEU</p>	<p>Titre</p> <p>24 - PLAN EN COUPE EOLIENNES 1 & 2 - V126</p>	Date	27/06/2017
			Chef de projet	S. MAURER
			Dessinateur	L.PALVADEAU
			<p>VESTAS V126 / NORDEX N131</p>	

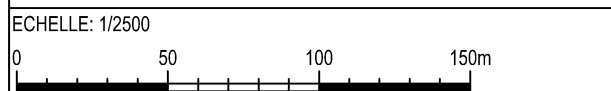
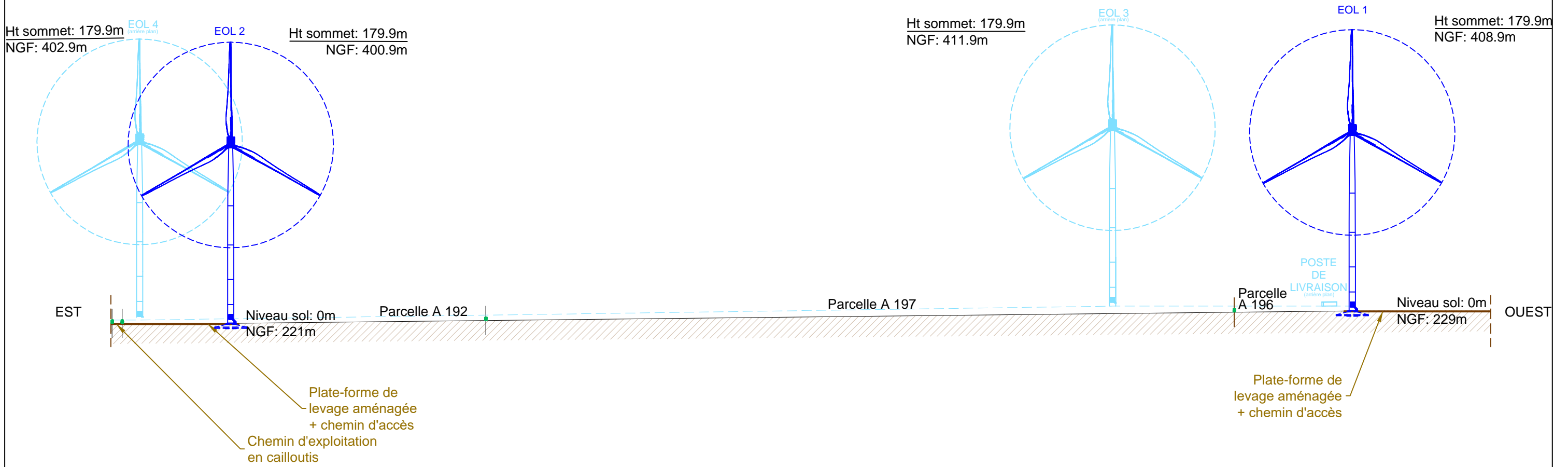
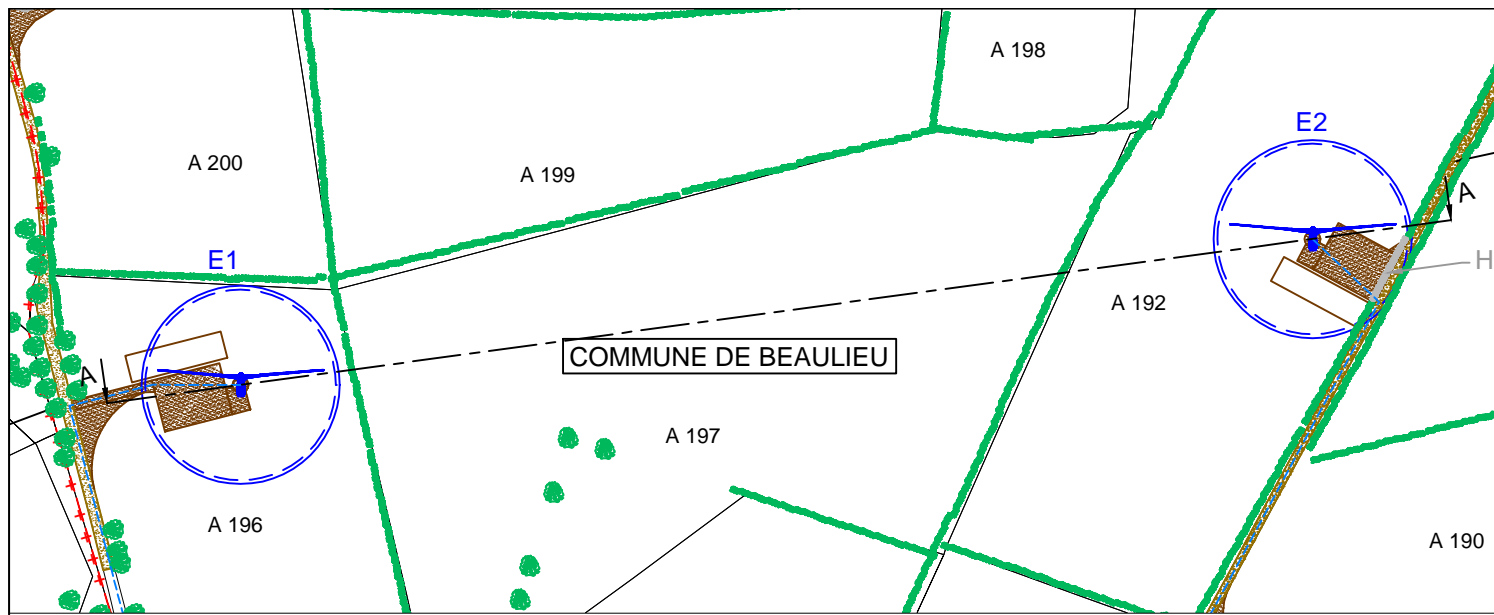

 <p>INERSYS ZA des Métairies II - BP 48 - NIVILLAC 56130 LA ROCHE BERNARD</p> <p>Tél: 02 99 90 87 07 Fax: 02 99 90 73 08</p>	<p>Projet</p> <p>PARC EOLIEN BEAULIEU</p>	<p>Titre</p> <p>24' - PLAN EN COUPE EOLIENNES 1 & 2 - N131</p>	Date	27/06/2017
			Chef de projet	S. MAURER
			Dessinateur	L.PALVADEAU
			<p>VESTAS V126 / NORDEX N131</p>	

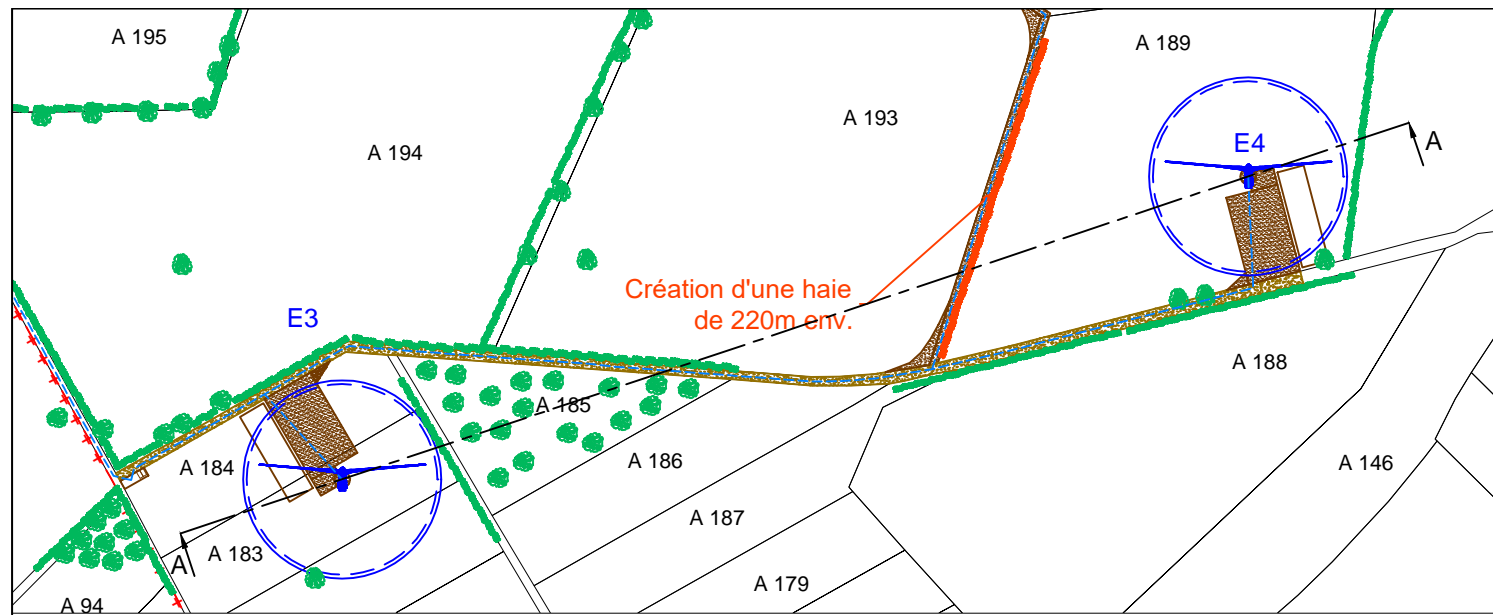

Ht sommet: 180.3m
NGF: 409.3m

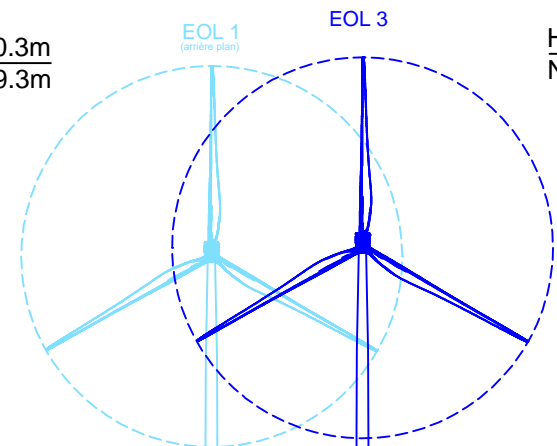

Ht sommet: 180.3m
NGF: 412.3m

Ht sommet: 180.3m
NGF: 403.3m

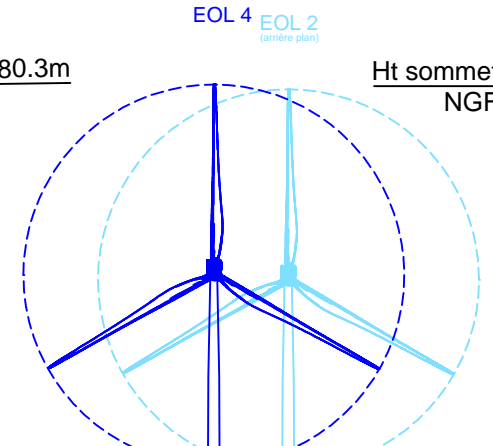

Ht sommet: 180.3m
NGF: 401.3m

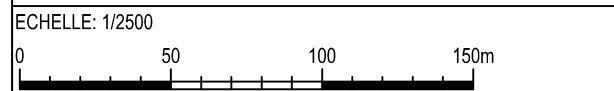
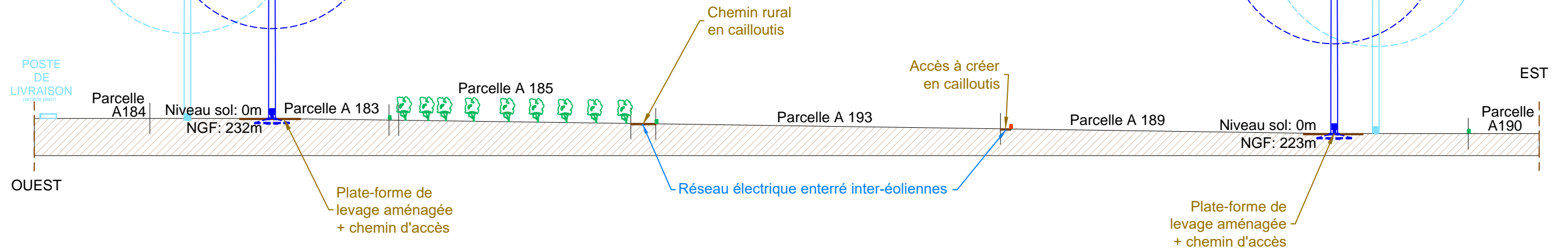

<p>INERSYS ZA des Métaïries II - BP 48 - NIVILLAC 56130 LA ROCHE BERNARD</p> <p>Tél: 02 99 90 87 07 Fax: 02 99 90 73 08</p>	<p>Projet</p> <p>PARC EOLIEN BEAULIEU</p>	<p>Titre</p> <p>25 - PLAN EN COUPE EOLIENNES 3 & 4 - V126</p>	Date	27/06/2017
			Chef de projet	S. MAURER
			Dessinateur	L.PALVADEAU
			<p>VESTAS V126 / NORDEX N131</p>	

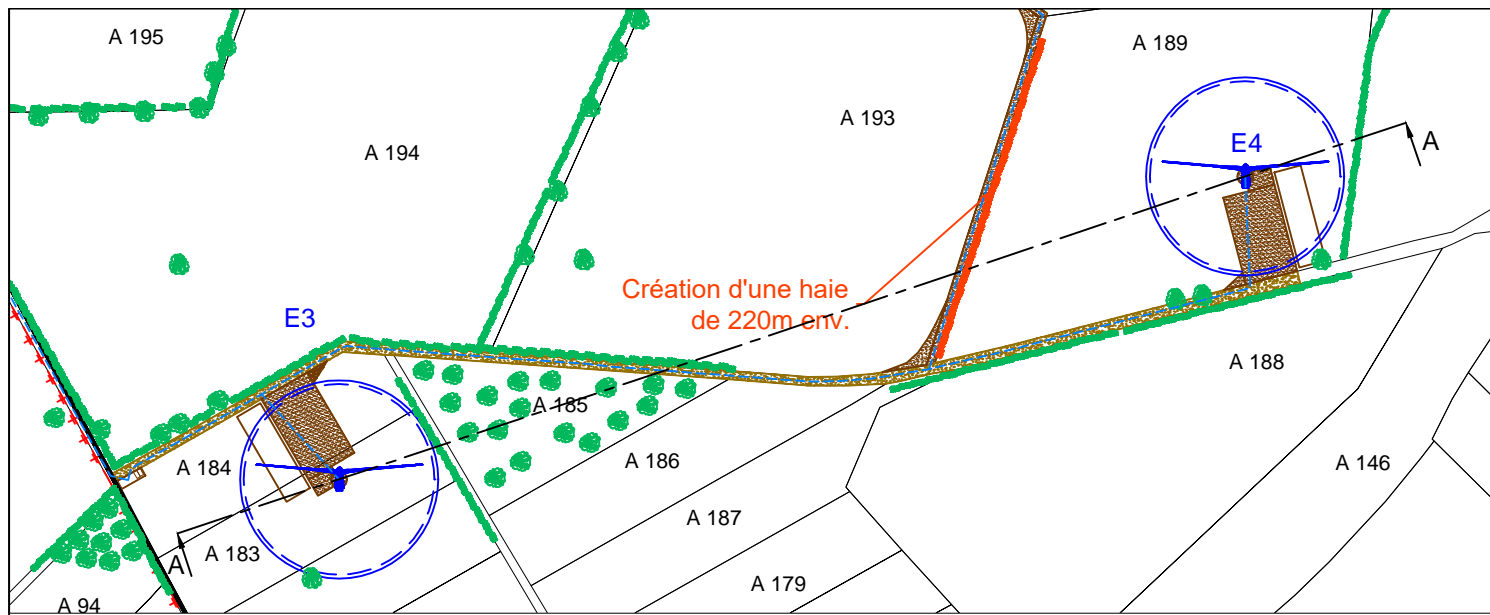

Ht sommet: 179.9m
NGF: 408.9m

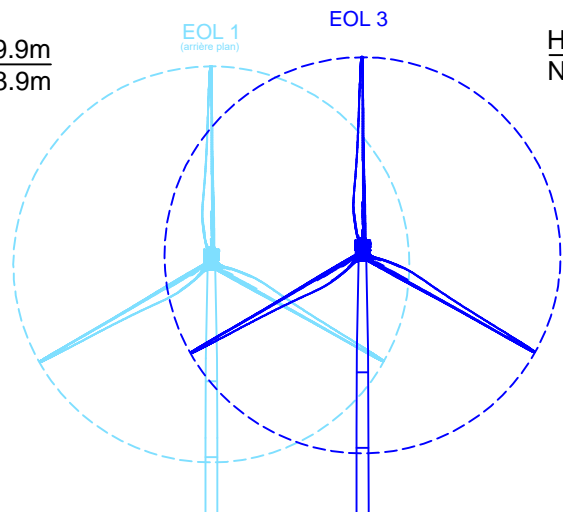

Ht sommet: 179.9m
NGF: 411.9m

Ht sommet: 179.9m
NGF: 402.9m

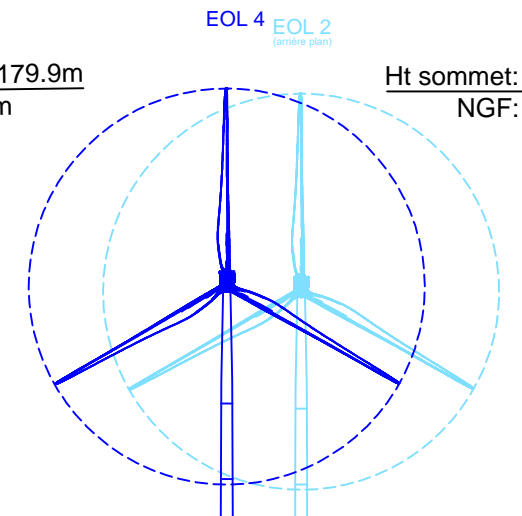

Ht sommet: 179.9m
NGF: 400.9m

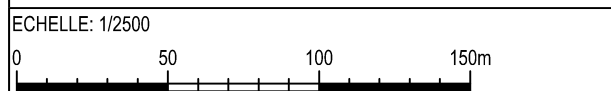
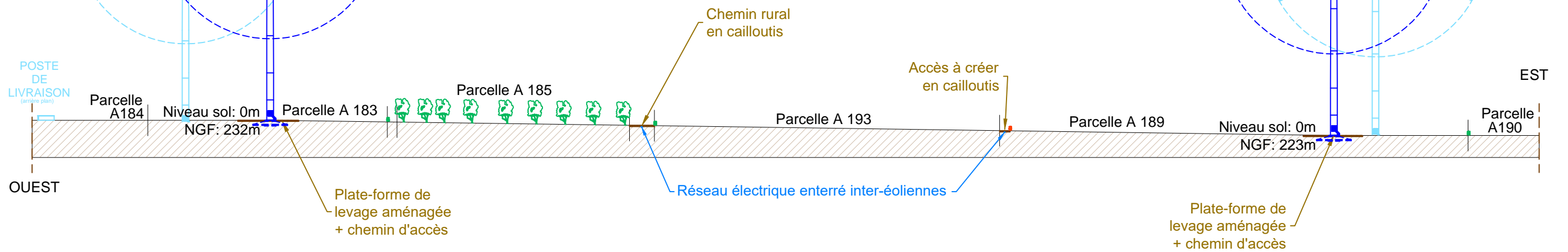

<p>INERSYS ZA des Métaïries II - BP 48 - NIVILLAC 56130 LA ROCHE BERNARD</p> <p>Tél: 02 99 90 87 07 Fax: 02 99 90 73 08</p>	<p>Projet</p> <p>PARC EOLIEN BEAULIEU</p>	<p>Titre</p> <p>25' - PLAN EN COUPE EOLIENNES 3 & 4 (N131)</p>	Date	27/06/2017
			Chef de projet	S. MAURER
			Dessinateur	L.PALVADEAU
			<p>VESTAS V126 / NORDEX N131</p>	

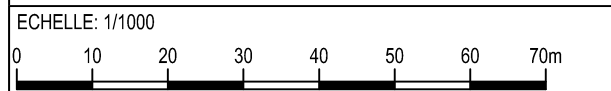
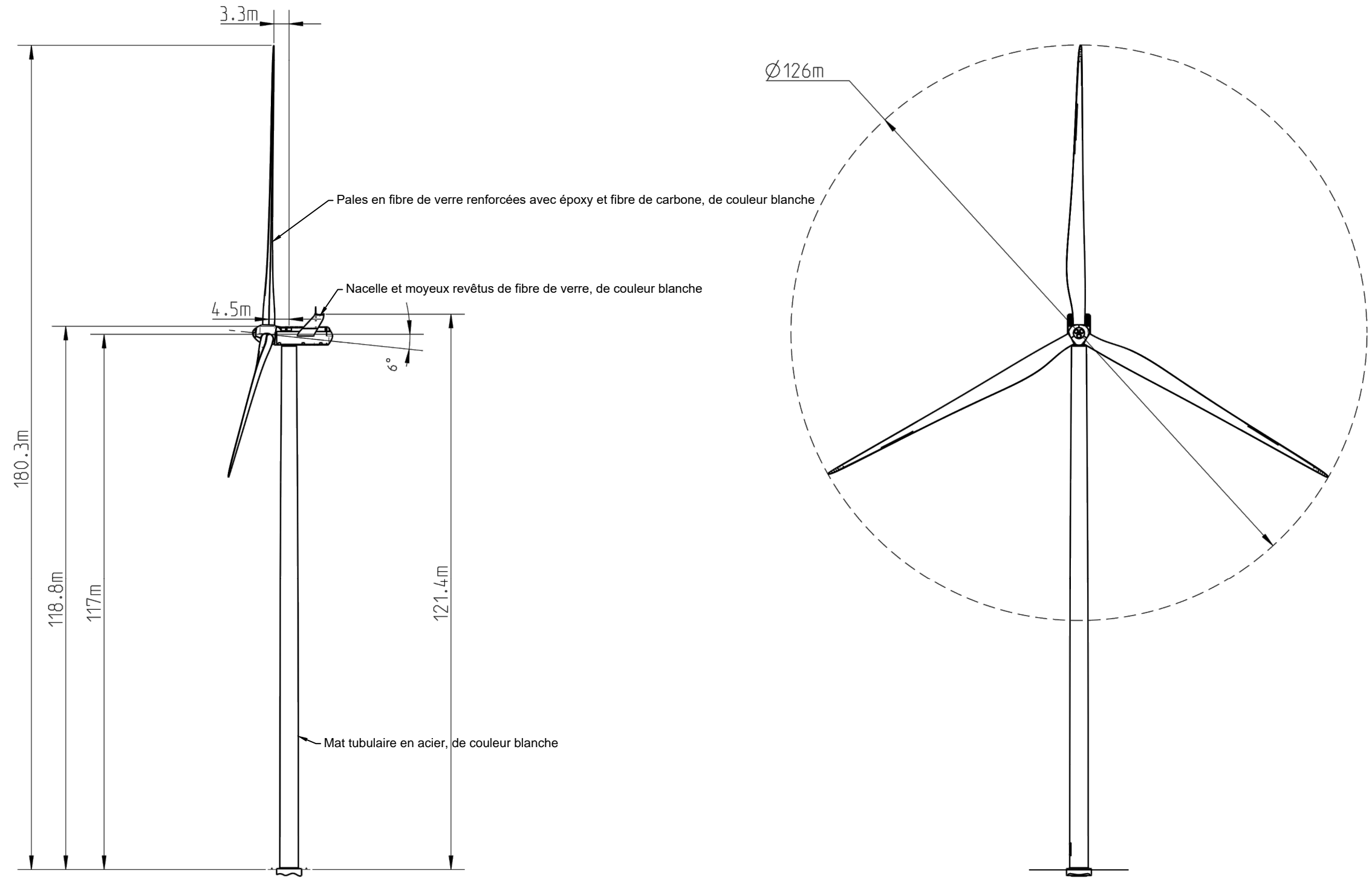

INERSYS

ZA des Métairies II - BP 48 - NIVILLAC
56130 LA ROCHE BERNARD

Tél: 02 99 90 87 07
Fax: 02 99 90 73 08

Projet

**PARC EOLIEN
BEAULIEU**

Titre

**26 - PLAN GENERAL EOLIENNE
VESTAS V126**

Date	27/06/2017
Chef de projet	S. MAURER
Dessinateur	L.PALVADEAU
VESTAS V126 / NORDEX N131	

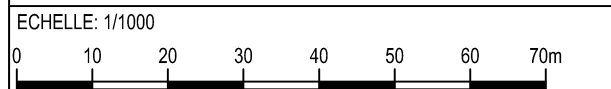
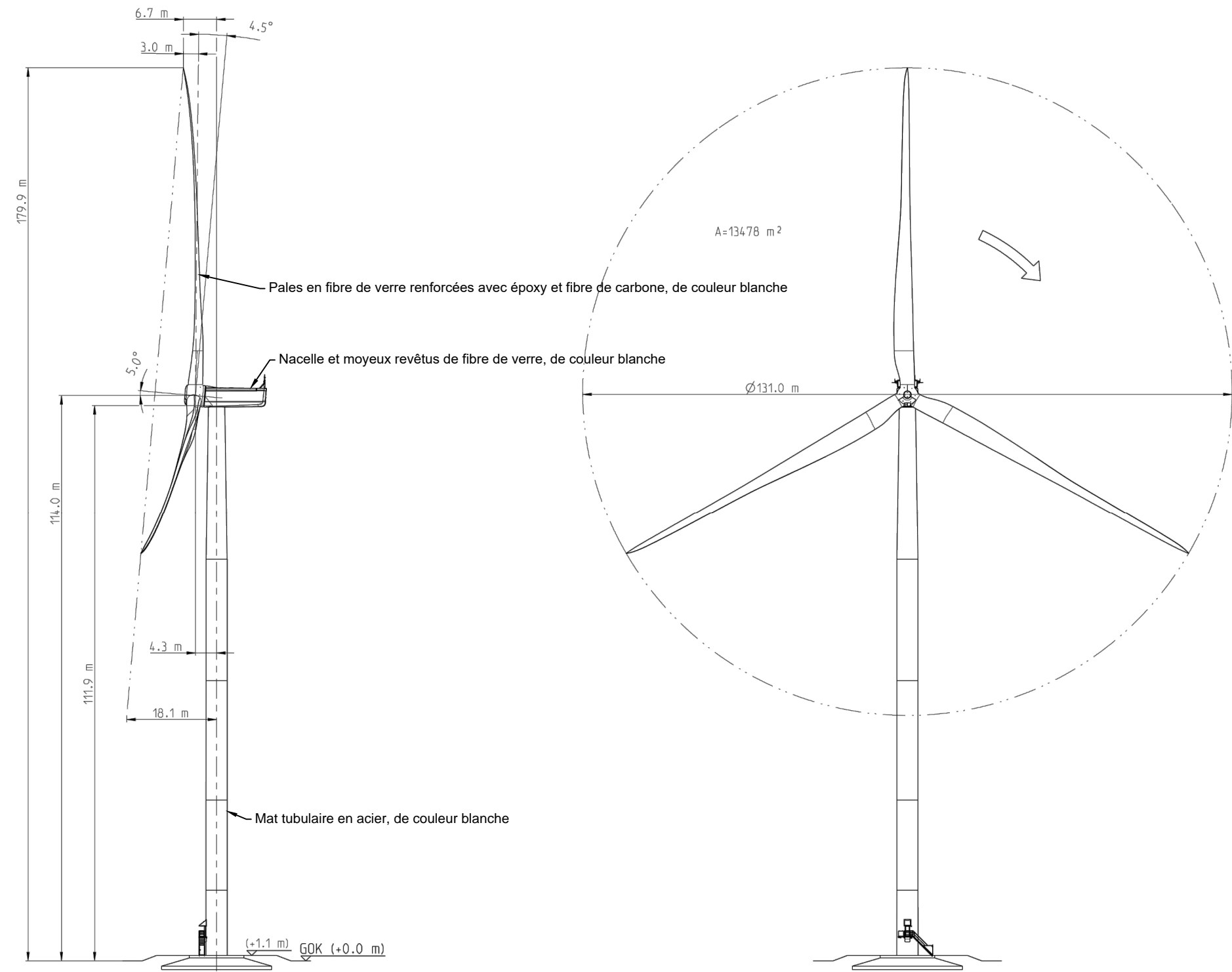

 <p>INERSYS ZA des Métairies II - BP 48 - NIVILLAC 56130 LA ROCHE BERNARD</p> <p>Tél: 02 99 90 87 07 Fax: 02 99 90 73 08</p>	<p>Projet</p> <p>PARC EOLIEN BEAULIEU</p>	<p>Titre</p> <p>26' - PLAN GENERAL EOLIENNE NORDEX N131</p>	Date	27/06/2017
			Chef de projet	S. MAURER
			Dessinateur	L.PALVADEAU
			<p>VESTAS V126 / NORDEX N131</p>	

Facade sud

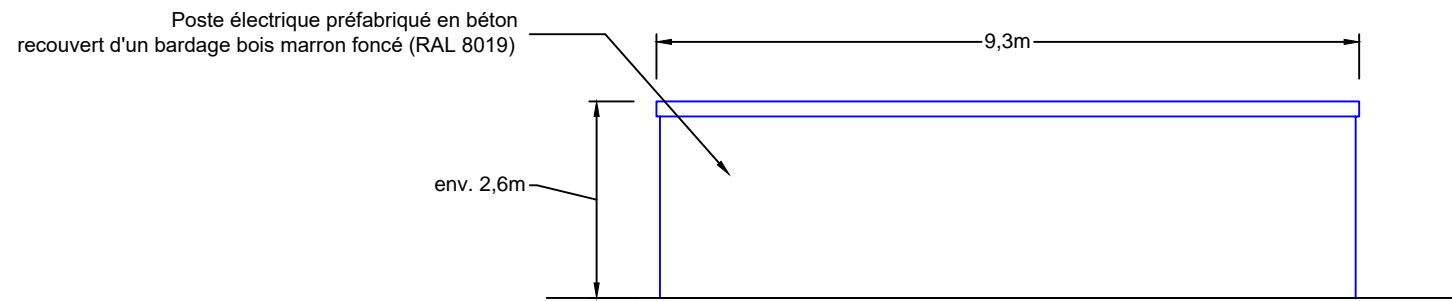

Facade ouest

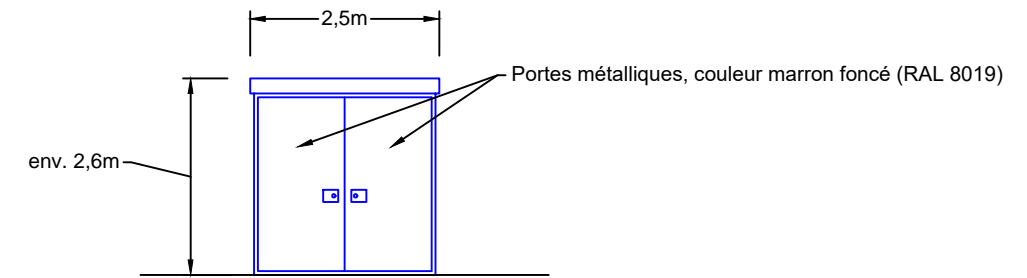

Facade nord

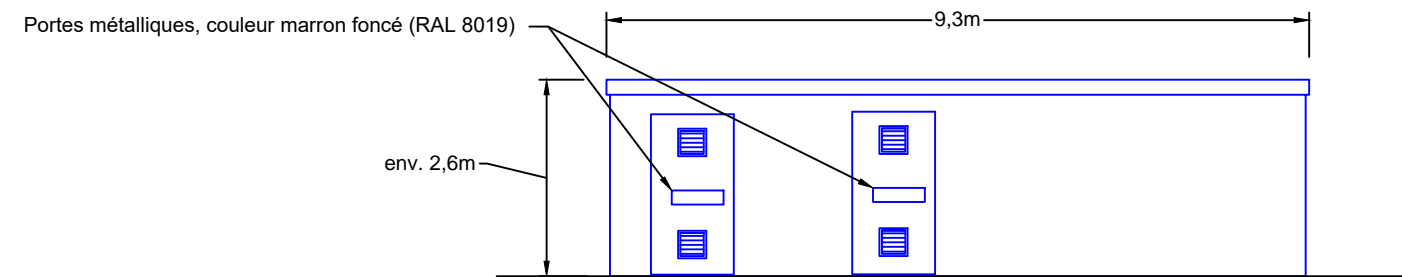

Facade est

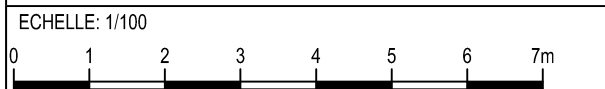
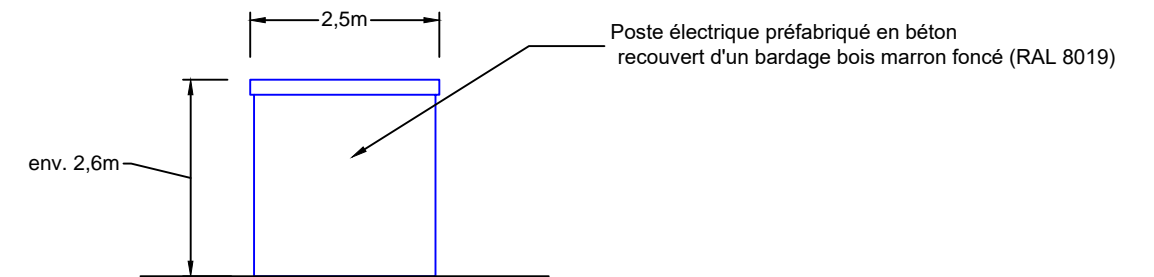

INERSYS

ZA des Métairies II - BP 48 - NIVILLAC
56130 LA ROCHE BERNARD

Tél: 02 99 90 87 07
Fax: 02 99 90 73 08

Projet

**PARC EOLIEN
BEAULIEU**

Titre

**27 - PLAN DES FACADES
POSTE DE LIVRAISON**

Date	27/06/2017
Chef de projet	S. MAURER
Dessinateur	L.PALVADEAU
VESTAS V126 / NORDEX N131	



INERSYS

ZA des Métairies II - BP 48 - NIVILLAC
56130 LA ROCHE BERNARD
Tél: 02 99 90 87 07
Fax: 02 99 90 73 08

LEGENDE

- HYPOTHESES DE TRACÉ DE RACCORDEMENT ÉLECTRIQUE EXTERNE (sous maîtrise d'oeuvre ENEDIS)
- RESEAU ELECTRIQUE ENTERRE INTER-EOLIENNE
- RESEAU ELECTRIQUE AERIEN EXISTANT (90kV)

ECHELLE: 1/60 000

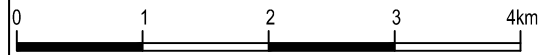

Projet

**PARC EOLIEN
BEAULIEU**

Titre

**28 - PLAN DES TRACÉS POTENTIELS
DE RACCORDEMENT**

Date 27/06/2017

Chef de projet S. MAURER

Dessinateur L. PALVADEAU

VESTAS V126 / NORDEX N131

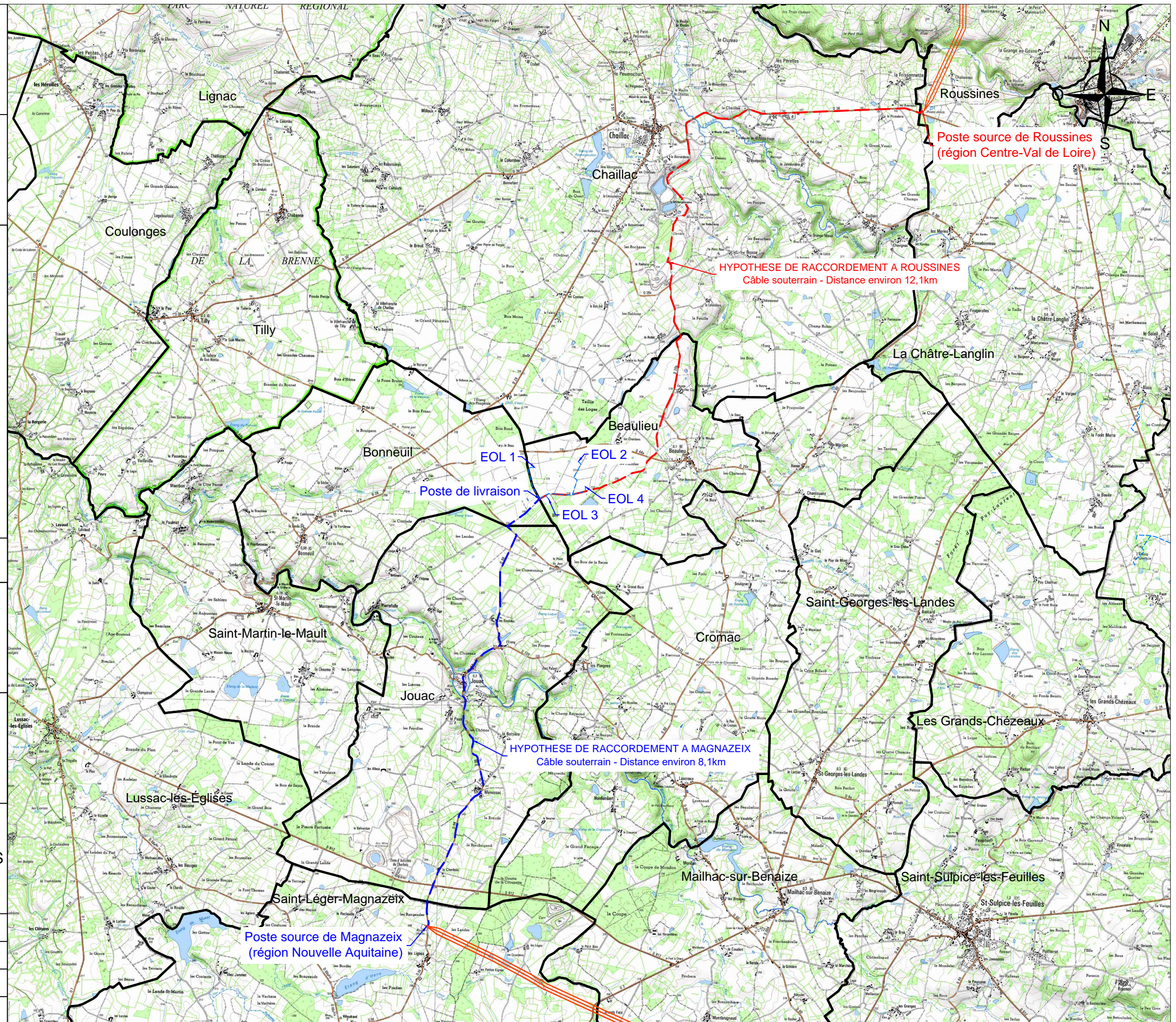



INERSYS

ZA des Métairies II - BP 48 - NIVILLAC
56130 LA ROCHE BERNARD
Tél: 02 99 90 87 07
Fax: 02 99 90 73 08

LEGENDE

 Périmètre de 6km autour de l'installation

ECHELLE: 1/50000

Projet

**PARC EOLIEN
BEAULIEU**

Titre

**29 - PÉRIMÈTRE DE 6KM
LIMITES COMMUNALES**

Date 27/06/2017

Chef de projet S. MAURER

Dessinateur L. PALVADEAU

VESTAS V126 / NORDEX N131

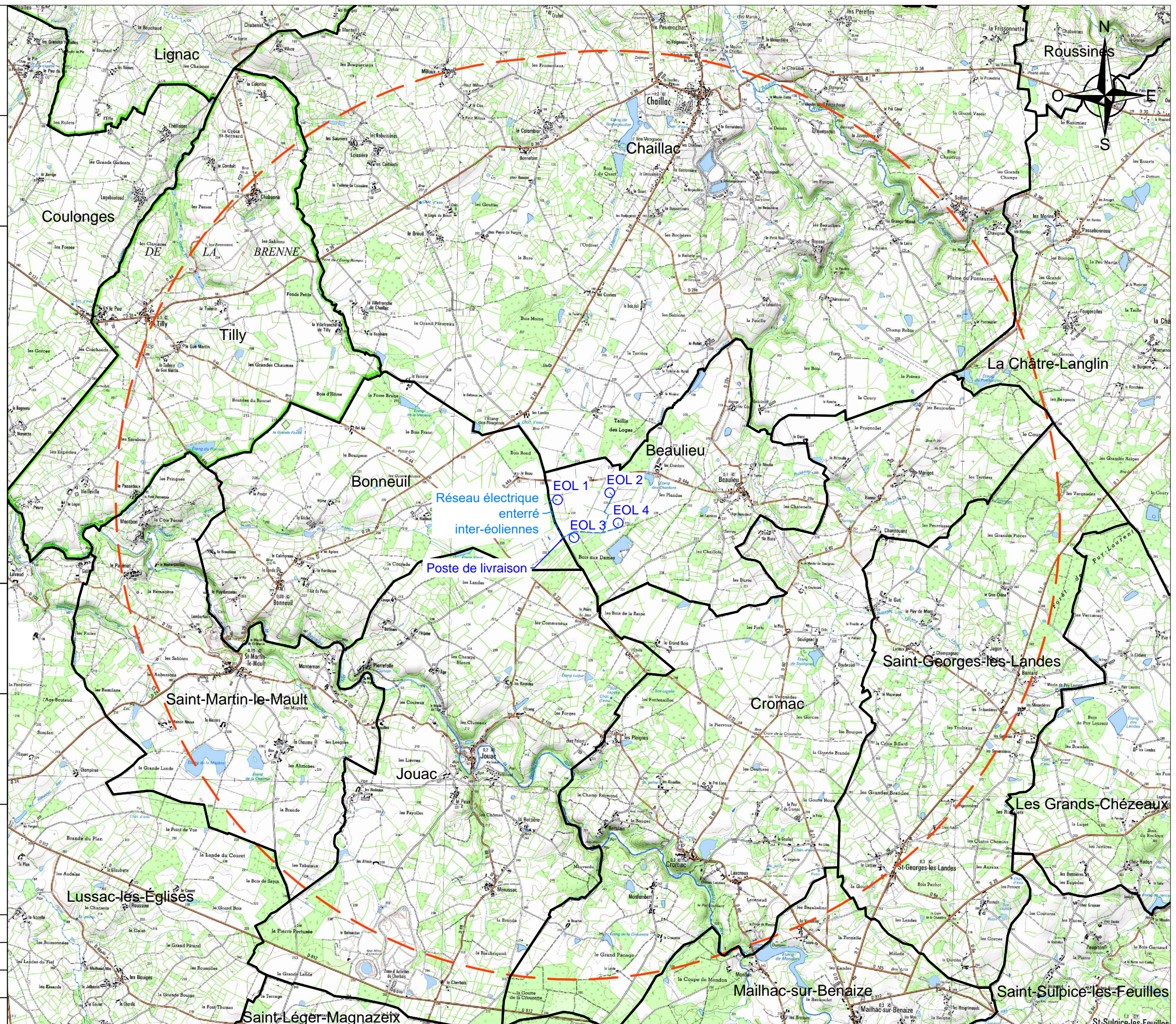

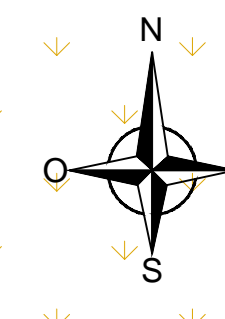

- LEGENDE**
- EOLIENNE VESTAS V126
 - EOLIENNE NORDEX N131
 - CHEMIN D'ACCES
 - DISTANCE DE 30m DE L'INSTALLATION
 - PARCELLES AGRICOLES
 - ZONE FORESTIERE
 - ETENDUE D'EAU / ETANG
 - BATIMENT AGRICOLE
 - HABITATIONS ET DEPENDANCES

Aucun réseau enterré existant via 400 identifié dans l'emprise de ce plan

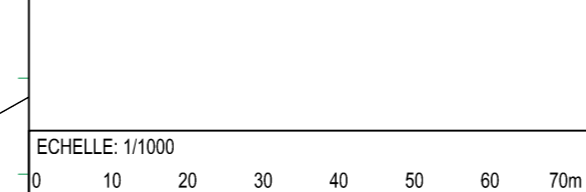
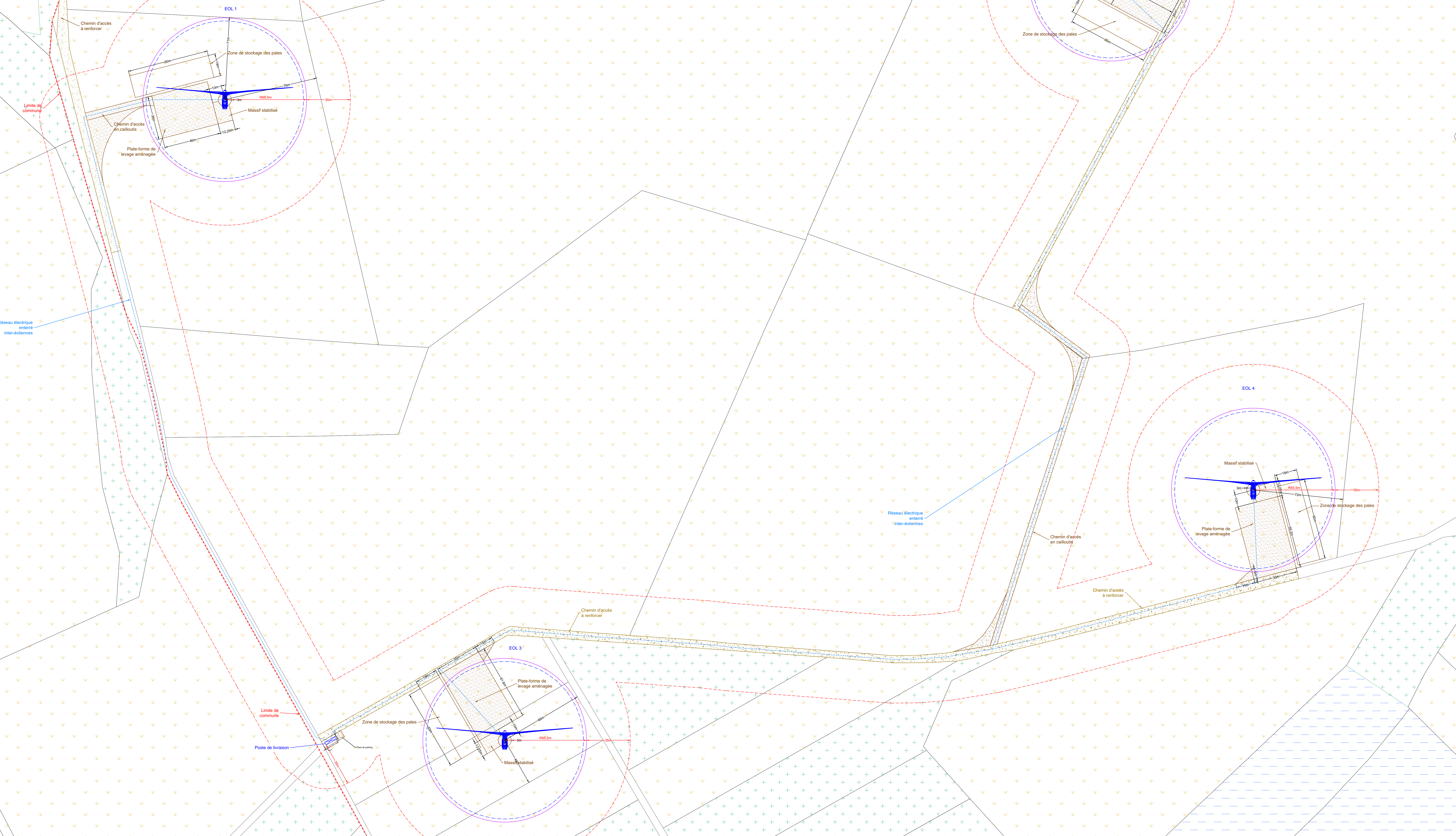

INERSYS
 ZA des Métaires II - BP 48 - NIVILLAC
 56130 LA ROCHE BERNARD
 Tél: 02 99 90 87 07
 Fax: 02 99 90 73 08

Projet
PARC EOLIEEN
BEAULIEU

Titre
30 - PLAN D'ENSEMBLE
DE L'INSTALLATION

Date	27/06/2017
Chef de projet	S. MAURER
Dessinateur	L.PALVADEAU
VESTAS V126 / NORDEX N131	

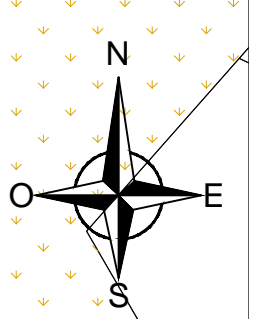

- LEGENDE**
- EQUIENNE VESTAS V126
 - EQUIENNE NORDEX N131
 - CHEMIN D'ACCES
 - DISTANCE DE 600m DE L'INSTALLATION
 - PARCELLES AGRICOLES
 - BATIMENT AGRICOLE
 - HABITATIONS ET DEPENDANCES
 - ETENDUE D'EAU / ETANG
 - ZONE FORESTIERE

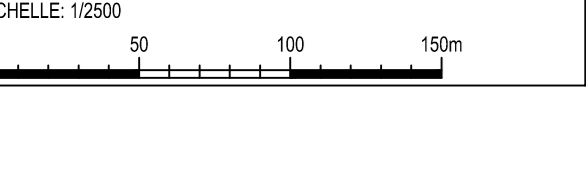
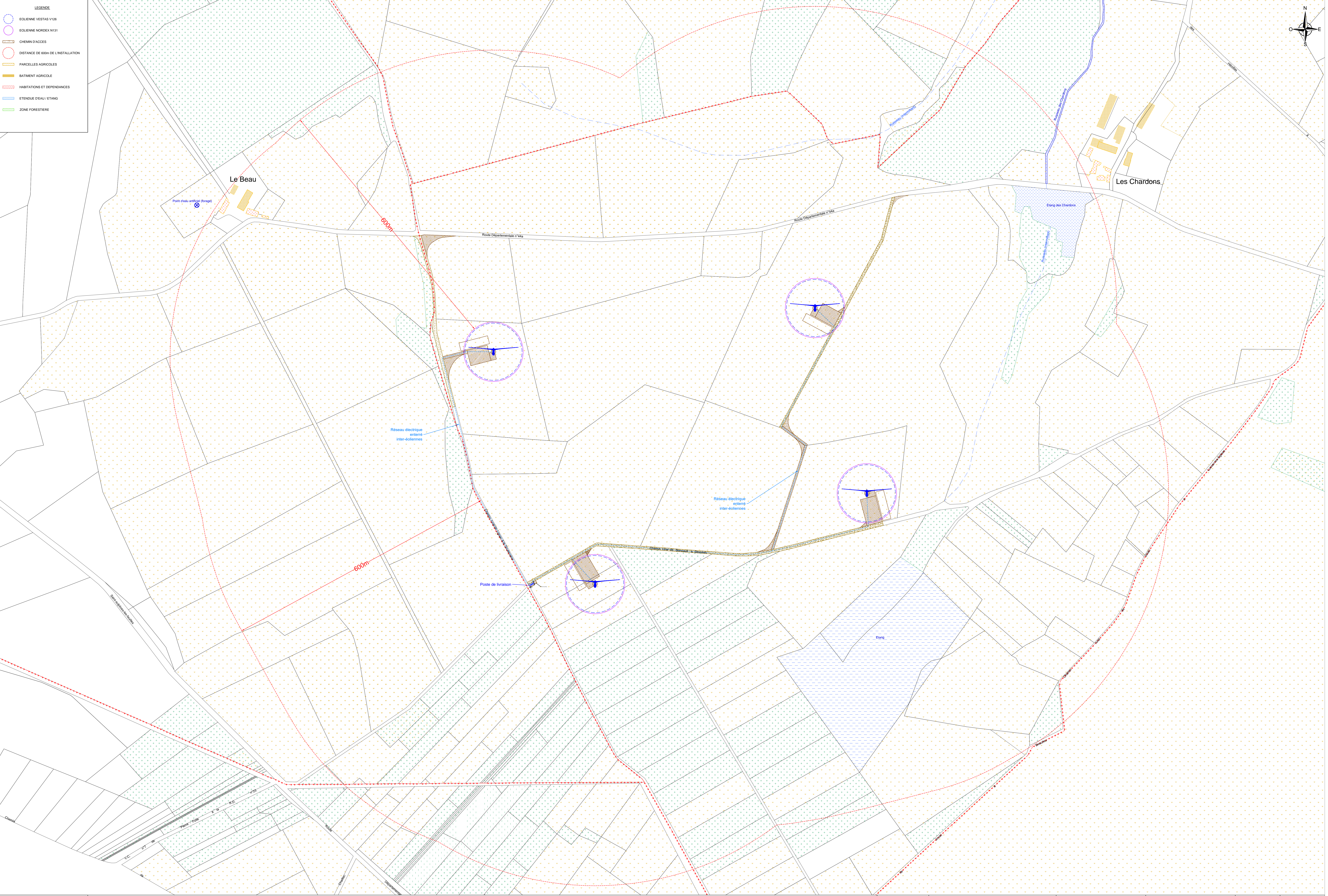

INERSYS
 ZA des Métaires II - BP 48 - NIVILLAC
 56130 LA ROCHE BERNARD
 Tel: 02 99 90 87 07
 Fax: 02 99 90 73 08

Projet
PARC EOLIEN
BEAULIEU

Titre
31 - PLAN DES ABORDS
DE L'INSTALLATION

Date	27/06/2017
Chef de projet	S. MAURER
Dessinateur	L.PALVADEAU
VESTAS V126 / NORDEX N131	